



ALUTEC
elite ROOF OUTLET SYSTEMS

Installation Guide

Outlets Typical Applications

IMPORTANT:

COMMON INSTALLATION TASKS APPLICABLE TO ALL INSTALLATIONS

- Fit threaded pipe connector into the outlet body as per the label attached to each threaded pipe connector, **using silicone sealant (SC101)**.
- Fill any structural voids to the underside of the outlet with mortar or insulation as appropriate.
- Fit a fire collar or wrap around the protruding plastic pipe against the underside of the roof structure, if the pipe projects into a building

COLD ROOFS AND CAR PARKS

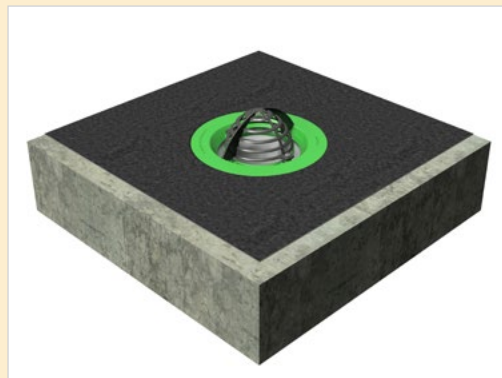
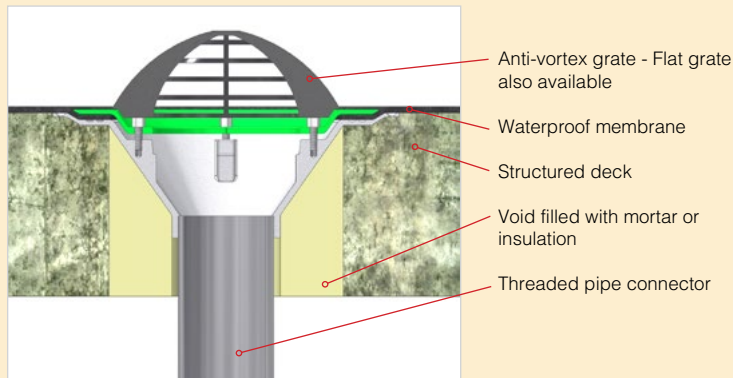

GRP, Cold Liquid, Hotmelt or Asphalt Waterproofing Membranes

1. Remove the membrane clamp ring, wax paper ring including butyl seals & three foam transit spacers located within the throat of the outlet and discard.
2. Place roof outlet body (with pipe connector fitted) centrally over structural opening.
3. Dress/apply waterproofing membrane over the recessed grooves of the outlet body.
4. Place membrane clamping ring over waterproofing membrane, then secure to outlet body with the 4 Nr male/female insert bolts. (Use the 4 threaded rods and belts supplied for asphalt applications) Tighten bolts in a diagonal sequence to ensure even compression. Check tightness after 15-30 mins and further tighten if required.
5. Attach grating.

Sheet Waterproofing Membranes

1. Remove the dome/flat grate, membrane clamp ring & wax paper ring from the butyl seal rings, including three foam transit spacers located within the throat of the roof outlet.
2. Place roof outlet body with pipe connector fitted, centrally over structural opening.
3. Cut a 500mm square piece of the waterproofing membrane with a 220mm diameter hole in the centre and place centrally over roof outlet.
4. Place membrane clamping ring over waterproofing membrane, then secure to outlet body with 4 Nr male/female insert bolts. Tighten bolts in a diagonal sequence to ensure even compression. Check tightness after 15-30 mins and further tighten if required.
5. Attach grating.

WARM ROOFS

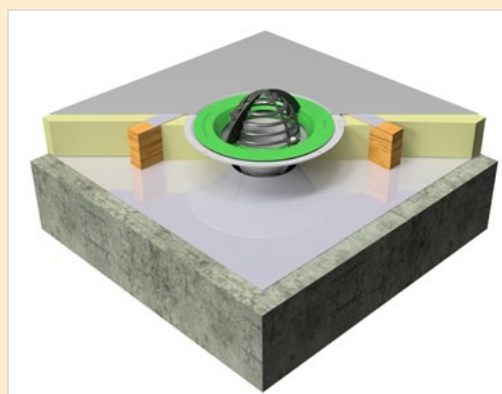
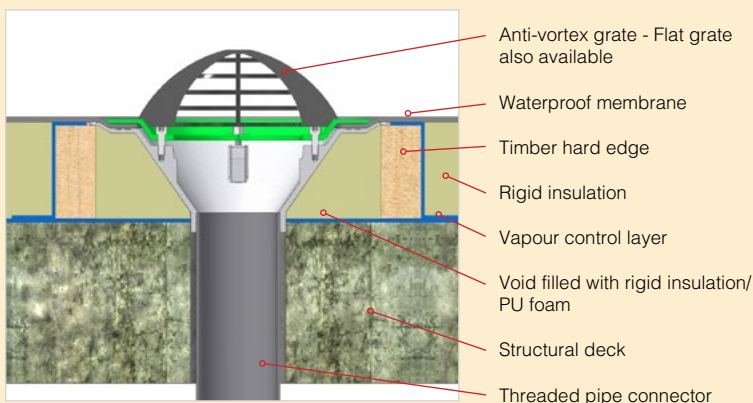

Sheet Waterproofing Membranes

1. The vapour control layer should be cut and sealed around the downpipe hole, within the deck, in accordance with the manufacturer's instructions.
2. Create a 340x340mm internal dimension timber or other suitable material kerb around the roof outlet structural opening to the same height as the insulation.
3. Flashing pieces of the vapour control layer should be dressed over the timber kerb and sealed to the main vapour control layer.
4. Place roof outlet onto the raised kerb, mark and recess the four contact areas so the top of the roof outlet and insulation are at the same height, then secure with 4 Nr A2 stainless steel screws (not supplied).
5. Cut rigid sections of insulation to infill the corners of the timber kerb.
6. Cut a 500mm square piece of the waterproofing membrane with a 220mm diameter hole centrally.
7. Remove the dome/flat grate, membrane clamp ring & wax paper ring from the butyl seal rings, including three foam transit spacers located within the throat of the roof outlet.
8. Place the 500mm square piece of waterproofing membrane over the outlet body ensuring the 220mmØ hole is central.
9. Place the membrane clamping ring over the waterproofing membrane, then secure to outlet body with 4 Nr male/female insert bolts. Tighten bolts in a diagonal sequence to ensure even compression. Check tightness after 15-30 mins and further tighten if required.
10. Attach grating.

Outlets Typical Applications

INVERTED BALLAST ROOF

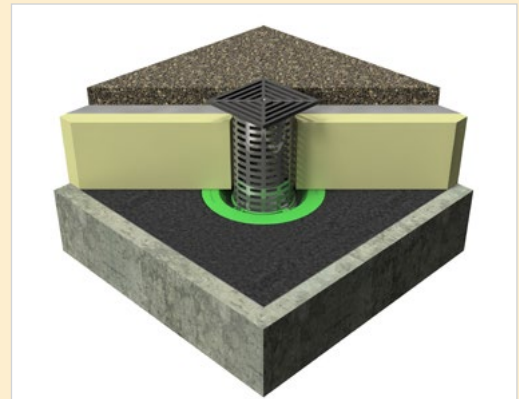
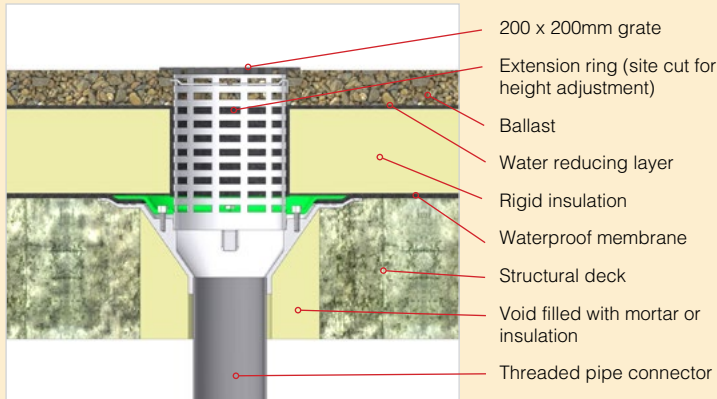

INVERTED PAVED ROOF (TERRACE)

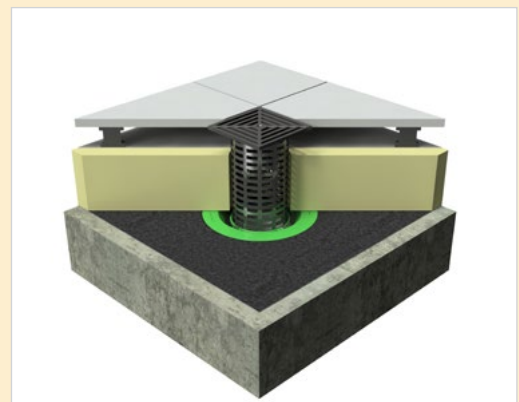
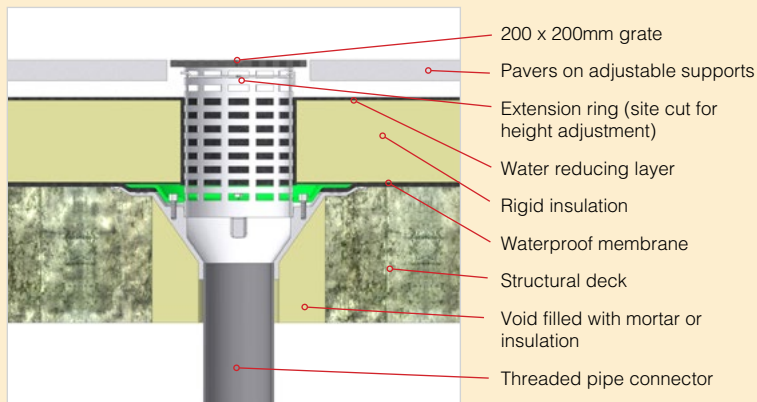

GREEN ROOF

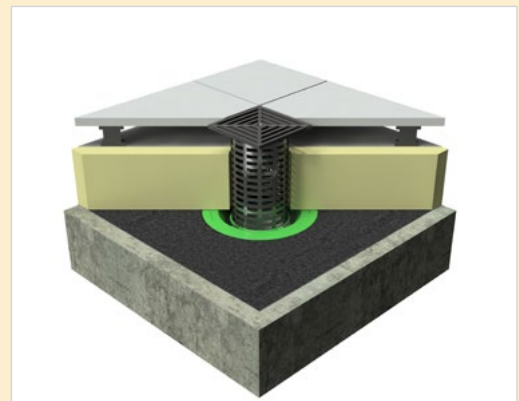
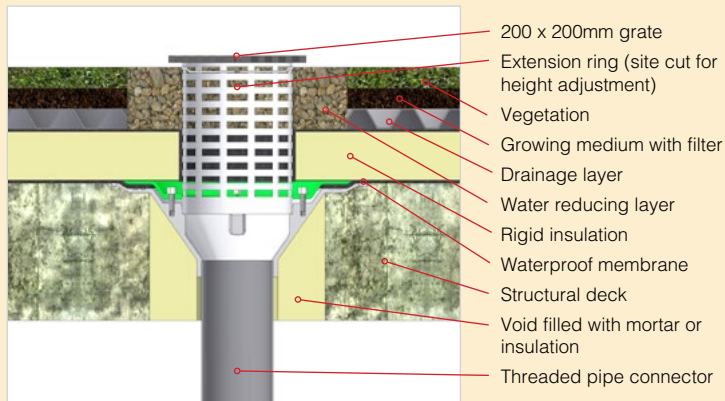

GRP, Cold Liquid and Hotmelt Waterproofing Membranes

1. Remove the membrane clamp ring, wax paper ring including butyl seals & three foam transit spacers located within the throat of the balcony outlet and discard.
2. Place roof outlet body with pipe connector fitted centrally over structural opening
3. Dress/apply waterproofing membrane over the recessed grooves of the outlet body.
4. Place membrane clamping ring over waterproofing membrane, then secure to outlet body with the 4 Nr male/female insert bolts. Tighten bolts in a diagonal sequence to ensure even compression. Check tightness after 15-30 mins and further tighten if required.
5. Insert the 160mmØ perforated extension into outlet throat. Place PIR insulation around the perforated extension. Cut the 160mmØ perforated extension to the required height (level with the finish top layer).
6. Remove perforated extension ring and dress the water runoff layer into the insulation void, then re-insert the perforated extension ring.
7. Insert the grate retaining bar through the uppermost perforations so that the threaded fixing hole is central. Place the 200 x200mm square grating into position and secure with screw provided.
8. Apply any further roof build-up components and dress around the outlet extension ring.

Sheet Waterproofing Membranes

1. Remove the membrane clamp ring. Remove the wax paper ring from the butyl seal rings including three foam transit spacers located within the throat of the roof outlet, and discard.
2. Place roof outlet body with pipe connector fitted centrally over structural opening.
3. Cut a 500mm square piece of the waterproofing membrane with a 220mm diameter hole in the centre and place centrally over roof outlet.
4. Place membrane clamping ring over waterproofing membrane, then secure to outlet body with 4 Nr male/female insert bolts. Tighten bolts in a diagonal sequence to ensure even compression. Check tightness after 15-30 mins and further tighten if required.
5. Insert the 160mmØ perforated extension into outlet throat. Place PIR insulation around the perforated extension. Cut the 160mmØ perforated extension to the required height (level with the finished top layer).
6. Remove perforated extension ring and dress the water runoff layer into the insulation void, then re-insert the perforated extension ring.
7. Insert the grate retaining bar through the uppermost perforations so that the threaded fixing hole is central. Place the square grating into position and secure with screw provided.
8. Apply any further roof build-up components and dress around the outlet extension ring.

Outlets Typical Applications

BLUE ROOF

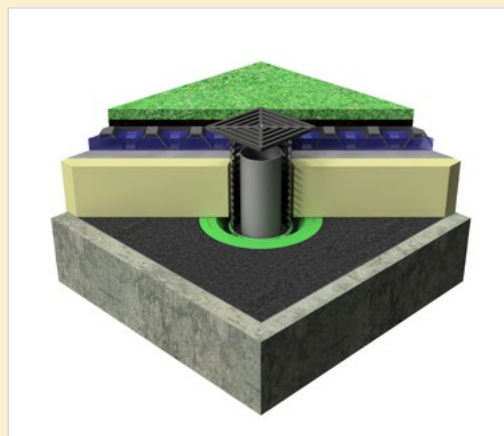
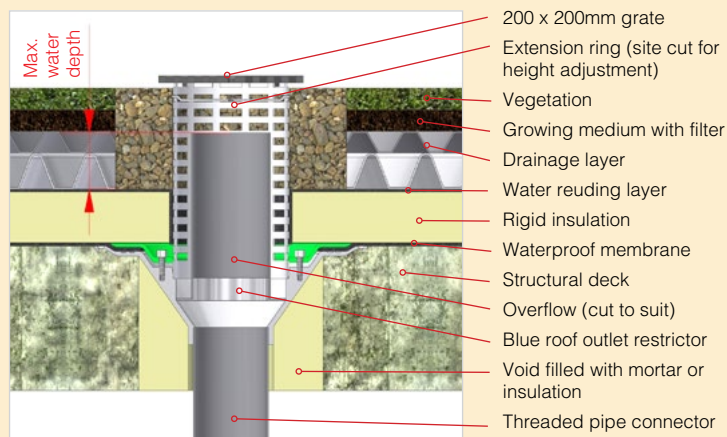

GRP, Cold Liquid, Hotmelt Waterproofing Membranes

1. Remove the membrane clamp ring, wax paper ring including butyl seals & three foam transit spacers located within the throat of the outlet and discard.
2. Place roof outlet body with pipe connector fitted centrally over structural opening
3. Dress/apply waterproofing membrane over the recessed grooves of the outlet body.
4. Place membrane clamping ring over waterproofing membrane, then secure to outlet body with the 4 Nr male/female insert bolts. Tighten bolts in a diagonal sequence to ensure even compression. Check tightness after 15-30 mins and further tighten if required.
5. Insert the 160mmØ perforated extension into outlet throat. Place PIR insulation around the perforated extension. Cut the 160mmØ perforated extension to the required height.
6. Remove perforated extension ring and dress the water runoff layer into the insulation void, then re-insert the perforated extension ring.
7. Place Blue Roof restrictor/overflow flange into the throat of the outlet body. Establish the maximum allowable water depth, mark and cut the overflow upstand to correspond accordingly.
8. Place and bed the flange of the Blue Roof restrictor onto an 8mm bead of silicone into the throat of the roof outlet.
9. Remove correct number of restrictor sealing plugs as instructed within the Blue Roof drainage design.
10. Re-insert the perforated extension ring. Insert grate retaining plate and fix square grating into position with screw provided.
11. Apply any further roof build-up components and dress around the outlet extension ring.

Sheet Waterproofing Membranes

1. Remove the membrane clamp ring. Remove the wax paper ring from the butyl seal rings including three foam transit spacers located within the throat of the roof outlet, and discard.
2. Place roof outlet body with pipe connector fitted centrally over structural opening.
3. Cut a 500mm square piece of the waterproofing membrane with a 220mm diameter hole in the centre and place centrally over roof outlet.
4. Place membrane clamping ring over waterproofing membrane, then secure to outlet body with 4 Nr male/female insert bolts. Tighten bolts in a diagonal sequence to ensure even compression. Check tightness after 15-30 mins and further tighten if required.
5. Insert the 160mm perforated extension into outlet throat. Place PIR insulation around the perforated extension. Cut the 160mm perforated extension to the required height.
6. Remove the perforated extension ring and dress the water runoff layer into the insulation void.
7. Place Blue Roof restrictor/overflow flange into the throat of the outlet body. Establish the maximum allowable water depth, mark and cut the overflow upstand to correspond accordingly.
8. Place and bed the flange of the Blue Roof restrictor onto an 8mm bead of silicone into the throat of the roof outlet.
9. Remove correct number of restrictor sealing plugs as instructed within the Blue Roof drainage design.
10. Re-insert the perforated extension ring. Insert grate retaining plate and fix square grating into position with screw provided.
11. Apply any further roof build-up components and dress around the outlet extension ring.

Outlets Typical Applications

PARAPET OUTLET – WARM, COLD AND INVERTED ROOFS

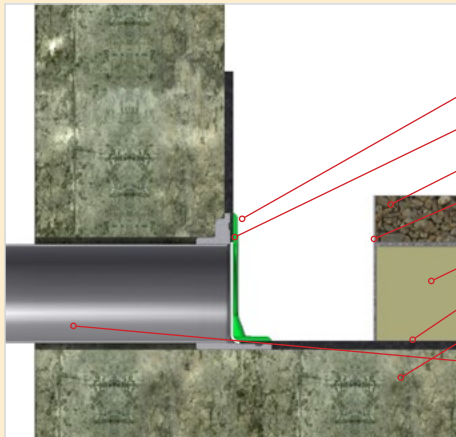

- Grate and compression clamp
- Parapet outlet
- Ballast
- Perforated 'L' section to retain ballast
- Rigid insulation
- Waterproof membrane
- Structural deck
- Threaded pipe connector

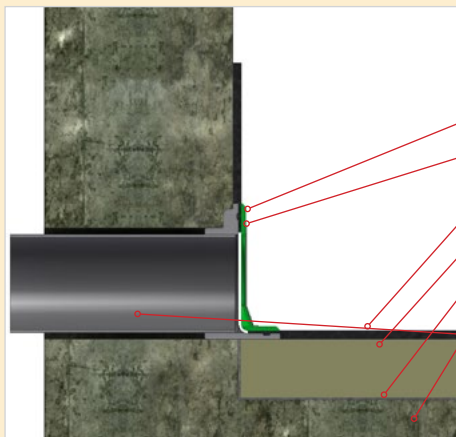
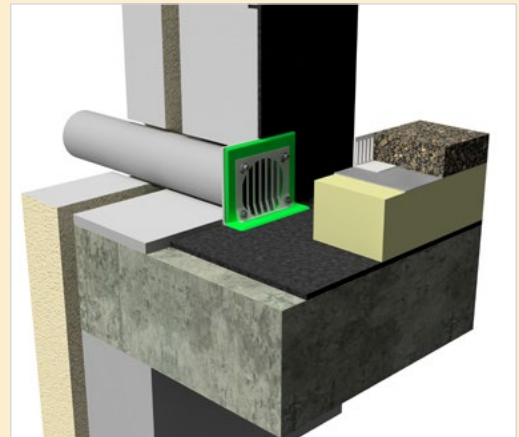

- Grate and compression clamp
- Parapet outlet
- Waterproof membrane
- Rigid insulation
- Vapour control layer
- Structural deck
- Threaded pipe connector

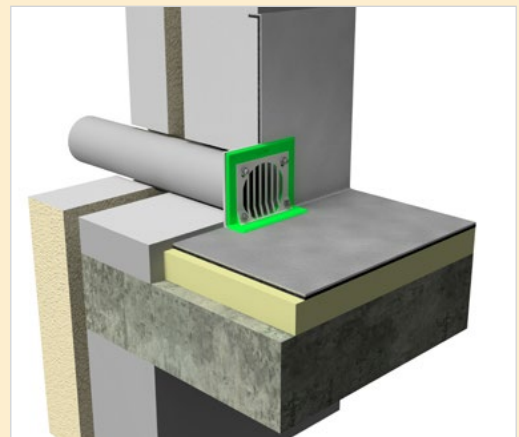

GRP, Cold Liquid, Hotmelt Waterproofing Membranes

1. Remove the L shaped membrane clamp flange & stainless-steel grate. Remove wax paper ring, butyl seal strips including three foam transit spacers located within the throat of the outlet and discard.
2. Insert roof outlet with pipe adaptor fitted, into the structural opening and secure with 2 Nr A2 grade stainless steel screws (not provided) into the vertical background.
3. Dress the waterproofing membrane over the recessed grooves of the outlet body.
4. Place L shaped membrane clamp flange and grate over waterproofing membrane, then secure to outlet body with the 2 nuts provided. Check tightness after 15-30 mins and further tighten if required.

Sheet Waterproofing Membranes

1. Remove the L shaped membrane clamp flange & stainless-steel grate, wax paper ring from butyl seal ring including three foam transit spacers located within the throat of the roof outlet.
2. Insert roof outlet with pipe adaptor fitted, into the structural opening and secure with 2 Nr A2 grade stainless steel screws (not provided) into the vertical background.
3. Create a 500mm sq. skirt from the waterproof membrane and cut a 90x112mm rectangular hole in the middle and place over the outlet body & butyl seal strips.
4. Place L shaped membrane clamp flange and grate over waterproofing membrane, then secure to outlet body with the 2 nuts provided. Check tightness after 15-30 mins and further tighten if required.

Inverted roofs - A localised sump area/void, adjacent to the outlet, should be left within the insulation of approximately 200x200mm in size. The void area can be left open or backfilled with ballast.

Outlets Typical Applications

UN-INSULATED BALCONIES

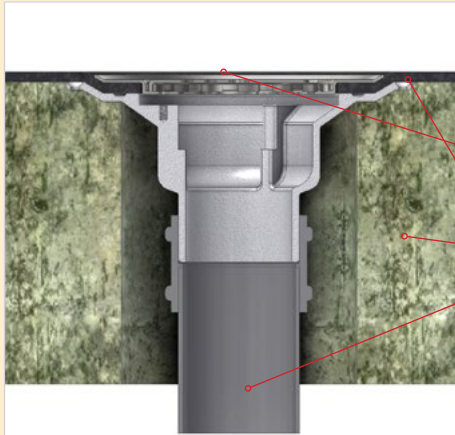

- Polished steel plate grate and compression clamp
- Waterproof membrane
- Structural deck
- Connecting pipework

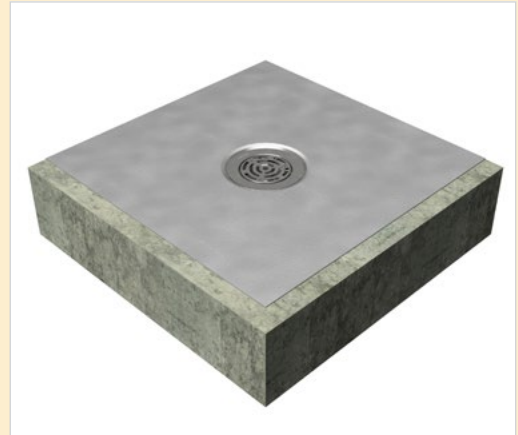

GRP, Cold Liquid and Hotmelt Waterproofing Membranes

1. Remove the membrane clamp ring, wax paper ring including butyl seals & three foam transit spacers located within the throat of the balcony outlet and discard.
2. Insert balcony outlet into the structural opening and secure with A2 grade stainless steel screws (not supplied).
3. Dress the waterproofing membrane over the recessed grooves of the outlet body
4. Place membrane clamping ring over waterproofing membrane, then secure to outlet body with the 3Nr bolts provided. Tighten bolts in a diagonal sequence to ensure even compression. Check tightness after 15-30 mins and further tighten if required.
5. Place circular grate over outlet and secure with screws provided.

Sheet Waterproofing Membranes

1. Remove the membrane clamp ring, wax paper ring, including three foam transit spacers located within the throat of the balcony outlet and discard.
2. Insert balcony outlet into the structural opening and secure with A2 grade stainless steel screws (not supplied).
3. Create a 500mm sq. skirt from the waterproof membrane and cut a 135mm diameter hole in the middle. Centralise skirt over the outlet body.
4. Place membrane clamping ring over waterproofing membrane, then secure to outlet body with the 3Nr bolts provided. Tighten bolts in a diagonal sequence to ensure even compression. Check tightness after 15-30 mins and further tighten if required.
5. Place circular grate over outlet and secure with screws provided.

PAVED/DECKED BALCONIES

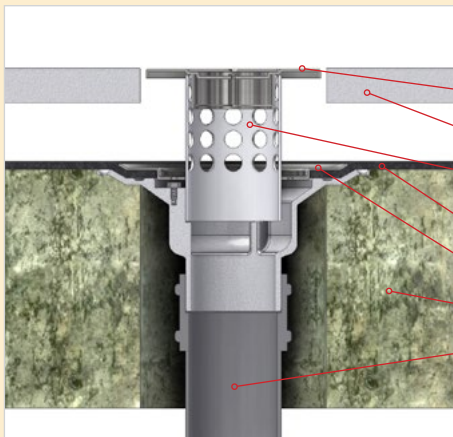

- Polished steel terrace grate
- Pavers on adjustable supports
- Extension ring (site cut for height adjustment)
- Waterproof membrane
- Compression clamp
- Structural deck
- Connecting pipework

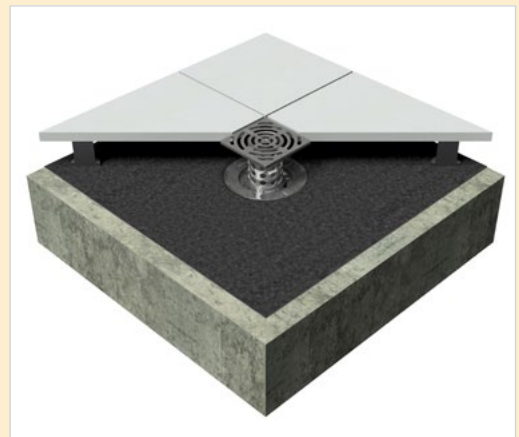

GRP, Cold Liquid and Hotmelt Waterproofing Membranes

1. Remove the membrane clamp ring, wax paper ring including butyl seals & three foam transit spacers located within the throat of the balcony outlet and discard.
2. Insert balcony outlet into the structural opening and secure with A2 grade stainless steel screws (not supplied).
3. Dress the waterproofing membrane over the recessed grooves of the outlet body
4. Place membrane clamping ring over waterproofing membrane, then secure to outlet body with the 3Nr bolts provided. Tighten bolts in a diagonal sequence to ensure even compression. Check tightness after 15-30 mins and further tighten if required.
5. Insert perforated extension into outlet throat then mark the required height and cut down accordingly (5mm below finished floor level).
6. Press square tile grate spigot into the perforated extension.

Sheet Waterproofing Membranes

1. Remove the membrane clamp ring, wax paper ring, including three foam transit spacers located within the throat of the balcony outlet and discard.
2. Insert balcony outlet into the structural opening and secure with A2 grade stainless steel screws (not supplied).
3. Create a 500mm sq. skirt from the waterproof membrane and cut a 135mm diameter hole in the middle. Centralise skirt over the outlet body.
4. Place membrane clamping ring over waterproofing membrane, then secure to outlet body with the 3Nr bolts provided. Tighten bolts in a diagonal sequence to ensure even compression. Check tightness after 15-30 mins and further tighten if required.
5. Insert perforated extension into outlet throat then mark the required height and cut down accordingly (5mm below finished floor level).
6. Press square tile grate spigot into the perforated extension.

Outlets Typical Applications

INVERTED PODIUM/BALCONIES

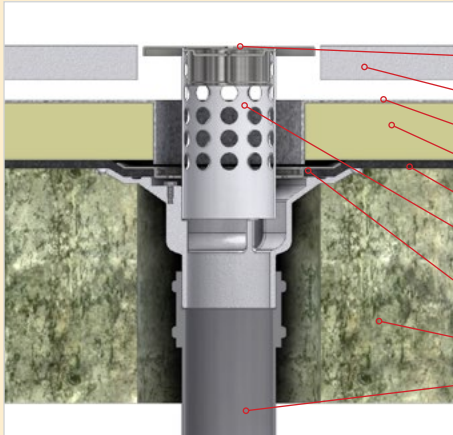

- Polished steel terrace grate
- Pavers on adjustable supports
- Water reducing layer
- Rigid insulation
- Waterproof membrane
- Extension ring (site cut for height adjustment)
- Compression clamp
- Structural deck
- Connecting pipework

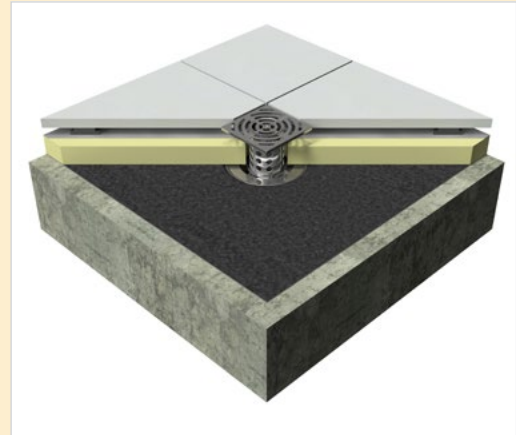

GRP, Cold Liquid and Hotmelt Waterproofing Membranes

1. Remove the membrane clamp ring, wax paper ring including butyl seals & three foam transit spacers located within the throat of the balcony outlet and discard.
2. Insert balcony outlet into the structural opening and secure with A2 grade stainless steel screws (not supplied).
3. Dress the waterproofing membrane over the recessed grooves of the outlet body
4. Place membrane clamping ring over waterproofing membrane, then secure to outlet body with the 3Nr bolts provided. Tighten bolts in a diagonal sequence to ensure even compression. Check tightness after 15-30 mins and further tighten if required.
5. Insert perforated extension into outlet throat then mark the required height and cut down accordingly (5mm below finished floor level). Place PIR insulation around the perforated extension.
6. Press square tile grate spigot into the perforated extension.

Sheet Waterproofing Membranes

1. Remove the membrane clamp ring, wax paper ring, including three foam transit spacers located within the throat of the balcony outlet and discard.
2. Insert balcony outlet into the structural opening and secure with A2 grade stainless steel screws (not supplied).
3. Create a 500mm sq. skirt from the waterproof membrane and cut a 135mm diameter hole in the middle. Centralise skirt over the outlet body.
4. Place membrane clamping ring over waterproofing membrane, then secure to outlet body with the 3Nr bolts provided. Tighten bolts in a diagonal sequence to ensure even compression. Check tightness after 15-30 mins and further tighten if required.
5. Insert perforated extension into outlet throat then mark the required height and cut down accordingly (5mm below finished floor level). Place PIR insulation around the perforated extension.
6. Press square tile grate spigot into the perforated extension.

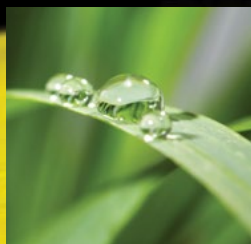

evolve RAINWATER SYSTEMS



traditional RAINWATER SYSTEMS



aligator RAINWATER SYSTEMS



evoke FASCIA, SOFFIT & COPING



elite ROOF OUTLET SYSTEMS

ALUTEC

ALUMINIUM RAINWATER SYSTEMS

Head office

For general enquiries, please call **01234 359438**
For technical enquiries please call **01234 344108**
email: enquiries@marleyalutec.co.uk
Fax: **01234 357199**

Unit 1 (G-H), Viking Industrial Park, Hudson Road,
Elms Farm Industrial Estate, Bedford MK41 0LZ

Export Division

Aliaxis UK
Dickley Lane, Lenham, Kent, ME17 2DE
Telephone: **01622 858888** Fax: **01622 850778**
email: export@aliaxis.co.uk

an *Aliaxis* company

 /marleyalutec

 @marleyalutec

 /company/marleyalutec

marleyalutec.co.uk